

UHP-T LED Illuminator with UHPTLCC-02 Controller User Manual



Ver 2.0

Main Office

Phone: +972-72-2500097
Fax: +972-72-2500096
sales@prizmatix.com

European Sales Office

Phone: +44-(0)77-9172-9592
Fax: +44-(0)20-7681-2977
sales.europe@prizmatix.com

North America Sales Office

Phone: +1-(248)-436-8085
Fax: +1-(248)-281-5236
sales.usa@prizmatix.com

P.O.B. 244 Givat-Shmuel 54101, Israel

Prizmatix

Contents

1	Introduction	3
1.1	Features	3
1.2	Intended use	3
	Safety	3
1.3	General safety	3
1.4	Eye safety	4
1.4.1	UHP-T illuminator assignment according to IEC 62471	4
1.4.2	Special safety notes	6
1.4.3	Hazard Distances (HD)	7
1.4.4	Permissible exposure duration (t_{max})	7
	Setup of the device	8
1.5	Package contents list	8
1.6	System overview:	8
1.7	UHP-T illuminator system connection	10
1.8	Use of UHP-T LED illuminator on a microscope	12
1.8.1	Setting of the illuminator LED head on the microscope	12
1.8.2	Illuminator alignment on the microscope	12
1.8.3	Disconnection of illuminator LED head from a microscope	13
1.9	Use of UHP-T LED illuminator for table-top illumination	13
1.10	LED Control by TTL and / or Analog Input	14
	Cleaning	14
	Specifications	15
1.11	Electrical specifications	15
1.12	General specifications	15

Prizmatix

1 Introduction

The UHP-T LED is an Ultra High Power LED light source for various laboratory applications including fluorescence microscopy, Optogenetics, high power illumination and other applications. It is an effective replacement for spectral lamps and lasers. The LED driver supports CW operation and TTL triggering.

1.1 Features

- Compatible with Prizmatix modular UHP-T-LED, UHP-Mic-LED and Mic-LED Light-Source products families – for creation of multi-wavelength setups for Fluorescence microscopy, Optogenetics, fiberoptic applications and more.
- Single chip Ultra High Brightness LED (Except UHP-T-LA product line).
- Optically isolated TTL input for external triggering (no shutter needed)
- Analog input (0-5V) for LED power control by external device
- LED spectrum can be narrowed by band pass filters or a filter wheel.
- Excellent for fluorescence excitation
- Stable precisely adjustable power
- Long life (no lamp or laser tube replacement required)
- Rapid warm up time

1.2 Intended use

The UHP-T is an Ultra-High-Power LED light source designed to be used in various scientific applications in laboratory. Few examples of use are fluorescence microscopy, whole body imaging of small animals (*in-vivo*), bio-analysis, photo-activation and numerous others.

Safety

1.3 General safety

Please make yourself familiar with the contents of these operating instructions before using the UHP-T system. Use the illuminator only as specified in this manual. Otherwise, the protection provided by the illuminator may be impaired.

The following symbols are used for the warnings:

 **CAUTION!** Failure to comply with the safety instructions can be hazardous to the user.

 **CAUTION!** Failure to comply with the safety instructions can result in damage to the instrument.

Do not use the illuminator if it is damaged. Before you use the illuminator, inspect the case. Look for cracks or missing parts.

Do not use the device around explosive gas.

Prizmatix

Never operate the illuminator with the cover removed or the case open.

Any maintenance should ONLY be performed by a Prizmatix authorized technician.

Prizmatix products are NOT authorized for use as components in life support devices or systems.

1.4 Eye safety

The UHP-T illuminator system is in **excess of the Exempt Group**. The viewer-related risk is highly dependent upon the use and installation of the product. For example if the product is attached to epifluorescence port of microscope the beam is restricted and in most case such system will be assigned to a Low Risk or Exempt Group, on the contrary if the illuminator is used for table top illumination of a Petri dish – such assembly may be of potentially High Risk Group. Each specific setup shall be evaluated and assigned to an appropriate risk group by the user and appropriate safety means should be taken. Herein below a free space unrestricted setup is analyzed and various models of UHP-T illuminators are assigned to appropriate Risk Groups. This assignment is a worst case analysis.

1.4.1 UHP-T illuminator assignment according to IEC 62471

The UHP-T illuminator is assigned to following risk groups according to IEC 62471: 2006. The assignment done based on the standard system configuration for table top illumination. The assignment results are summarized in Table 1.

Table 1: UHP-T illuminator assignment to risk groups according to IEC 62471: 2006.

Product Type	Assignment to Risk Group			
	Exempt RG0	Low Risk RG1	Mod Risk RG2	High Risk RG3
UHP-T-405-EP				√
UHP-T-455-EP				√
UHP-T-520-EP			√	
UHP-T-625-EP		√		
UHP-T-White			√	

Prizmatix

The UHP-T illuminators are marked on the product with following labels:

Product	Safety Label
UHP-T-405-EP	<div style="border: 2px solid black; background-color: yellow; padding: 5px;"> <p style="text-align: center;">RISK GROUP 3</p> <p>WARNING UV emitted from this product. WARNING Possibly hazardous optical radiation emitted from this product</p> </div>
UHP-T-455-EP	<div style="border: 2px solid black; background-color: yellow; padding: 5px;"> <p style="text-align: center;">RISK GROUP 3</p> <p>WARNING Possibly hazardous optical radiation emitted from this product CAUTION Possibly hazardous optical radiation emitted from this product NOTICE UV emitted from this product</p> </div>
UHP-T-520-EP	<div style="border: 2px solid black; background-color: yellow; padding: 5px;"> <p style="text-align: center;">RISK GROUP 2</p> <p>CAUTION Possibly hazardous optical radiation emitted from this product</p> </div>
UHP-T-625-EP	Not required
UHP-T-White	<div style="border: 2px solid black; background-color: yellow; padding: 5px;"> <p style="text-align: center;">RISK GROUP 2</p> <p>CAUTION. Possibly hazardous optical radiation emitted from this product.</p> </div>

Prizmatix

1.4.2 Special safety notes

Table 2 summarize the safety notes specific to various product types (IEC/TR 62471-2, 2009 Tables 1 and 2).

Table 2: Safety labels specific to various product types

Product	Safety Label
UHP-T-405-EP	<p style="text-align: center;">RISK GROUP 3</p> <p>WARNING. UV emitted from this product. Avoid eye and skin exposure to unshielded product</p> <p>CAUTION. UV emitted from this product. Eye or skin irritation may result from exposure. Use appropriate shielding.</p> <p>CAUTION. Possibly hazardous optical radiation emitted from this product. Do not stare at operating lamp. May be harmful to the eyes.</p> <p>WARNING. Possibly hazardous optical radiation emitted from this product. Do not look at operating lamp. Eye injury may result.</p>
UHP-T-455-EP	<p style="text-align: center;">RISK GROUP 3</p> <p>WARNING. Possibly hazardous optical radiation emitted from this product. Do not look at operating lamp. Eye injury may result.</p> <p>CAUTION. Possibly hazardous optical radiation emitted from this product. Do not stare at operating lamp. May be harmful to the eyes.</p> <p>NOTICE UV emitted from this product. Minimize exposure to eyes and skin. Use appropriate shielding.</p>
UHP-T-520-EP	<p style="text-align: center;">RISK GROUP 2</p> <p>CAUTION. Possibly hazardous optical radiation emitted from this product. Do not stare at operating lamp. May be harmful to the eyes.</p>
UHP-T-625-EP	Not required
UHP-T-White	<p style="text-align: center;">Risk Group 2</p> <p>CAUTION. Possibly hazardous optical radiation emitted from this product. Do not stare at operating lamp. May be harmful to the eyes.</p>

Prizmatix

1.4.3 Hazard Distances (HD)

Following Table 3 provides the distance from distal end of the fiber at which the threshold illuminance EL returns the product to RG 1.

Table 3: Distances from distal end of the fiber at which the photochemical hazard reduces to Risk group 1, for relevant products.

Product	Distance at which Blue-Light hazard reduced to Risk Group 1
	[m]
UHP-T-405	8.0
UHP-T-455	11.5
UHP-T-520	2.4
UHP-T-625	Already within RG1 at 0.2m
UHP-T-White	4.4

1.4.4 Permissible exposure duration (t_{max})

The Permissible Exposure Durations for UHP-T product are calculated and reported in Table 4 below

Table 4: Permissible Exposure Durations for UHP-T product.







Product	Radiance	t_{max}
	[W·m ⁻² ·sr ⁻¹]	[sec]
UHP-T-405-EP	1.597E+05	6
UHP-T-455-EP	3.242E+05	3
UHP-T-520-EP	1.336E+04	75
UHP-T-625-EP	1.450E+02	6895
UHP-T-White	4.701E+04	21

Prizmatix

Setup of the device

Remove the device from the packaging and inspect the device for loose components or any signs of damage. Notify Prizmatix if the device appears damaged in any way: do not install or operate a damaged device.

1.5 Package contents list

(1)		(2)	
(3)		(4)	
(5)		(6)	

#	Item	Description	QTY
1	UHP-T-LED Head	UHP-T-LED head, with Olympus / Zeiss / Nikon / Leica microscope adaptor (optional)	1
2	UHPTLCC-02 Controller	Ultra-High Power LED Benchtop Current Controller	1
3	LED Control Cable	Cable to connect the UHP-T-LED to Controller	1
4	LED Current Cable	Cable to connect the UHP-T-LED to Controller	1
5	Mains Power Cord	Cord to connect the power adaptor to mains voltage	1
6	Power Adaptor	Universal power adaptor	1

1.6 System overview:

Prizmatix



Figure 1: Front panel of UHPTLCC-02 Current Controller: (1) LED light On/Off switch with internal LED indicator, (2) Power adjustment dial (10-turn potentiometer).



Figure 2: Back panel of UHPTLCC-02 Current Controller: (1) 12V DC power jack, (2) Power On/Off switch, (3) LED current cable connector (3 contacts) , (4) LED control cable connector (4 contacts), (5) TTL input connector, (6) TTL input enable toggle switch (external TTL input is enabled at “Ext” position), (7) Analog input connector, (8) Analog input enable toggle switch (external Analog input is enabled at “Ext” position).

! CAUTION! Both metal and plastic connectors have a key to prevent mating in incorrect orientation. Pay attention to connect the connectors correctly. Do not use excessive force!

Prizmatix

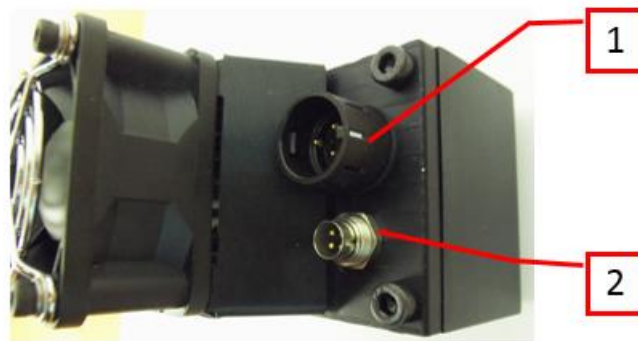

Figure 3: UHP-T LED illuminator head: (1) Connector for LED current cable, (2) Connector for LED control cable

1.7 UHP-T illuminator system connection

1. Check that power On/Off switch on back panel is in OFF position.
2. Check that ON/OFF green button on front panel of UHPLCC-02 current controller is in Off position (pulled out position)
3. Turn the LED power adjustment dial on the front panel of the current controller counterclockwise to the lowest setting
4. Connect the LED Control Cable and the LED Current Cable to the UHPTLCC-02 LED current controller and to the UHP-T-LED head (See Figure 4 and 5 below).

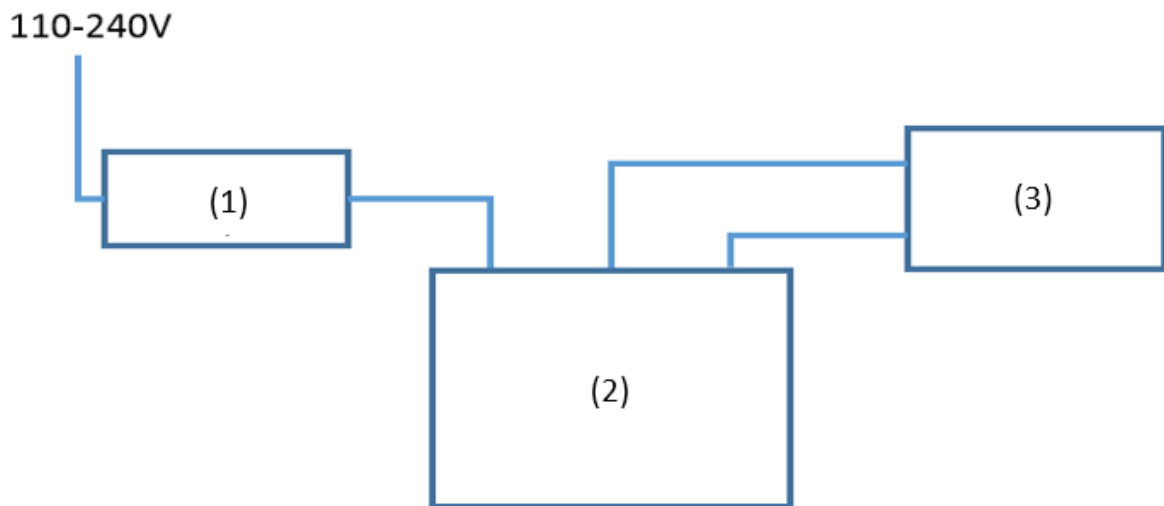

Figure 4: UHP-T LED Illuminator cable connection: (1) Power Adaptor, (2) UHPTLCC-02 LED controller, (3) UHP-T-LED head.

Prizmatix

5. Connect the Power Adaptor cord to the 12VDC jack on the back panel of the Current Controller.
6. Connect the Mains Power Cord to the Power Adaptor.
7. Plug the Power Adaptor into the wall outlet with the Mains Power Cord.
8. Switch all the Int / Ext toggle switches at the back panel of current controller to Int position.
9. Switch the Power Switch on back panel to ON position.
10. Push the LED button on the front panel (LED emission switch). The button will light up.
11. Adjust the dial control to the desired output power level.

! CAUTION! Never disconnect the power cord from the product before switching the ON/OFF switch button on front panel to OFF position

Note: The ON button's green indicator on the front panel will turn ON, ONLY if all the cables from LED head to controller are connected.

Note: The LED head contains a thermistor to regulate the temperature of the LED. The fan is activated only once the LED begins to warm up. When the LED is switched on from a cold state at the *maximum power* setting the fan will start to work after 5 - 30 seconds, depending on the LED wavelength and operation conditions.



Figure 5: Cable connections on the back panel of the UHPTLCC LED current controller

Prizmatix

1.8 Use of UHP-T LED illuminator on a microscope

1.8.1 Setting of the illuminator LED head on the microscope

1. The UHP-T-LED is designed to fit into the fluorescence lamp port of a microscope by using appropriate microscope adaptors.
2. Dismantle any existing fluorescence lamp (Hg, Xenon, etc.) from the microscope: most microscope manufacturers (Zeiss, Olympus, Leica) use set screws to tighten the lamp onto the port. Release the screws and carefully pull out the lamp. In the case of Nikon microscopes with an F-mount, turn the grooved collar counterclockwise and release the lamp.
3. Carefully insert the UHP-T-LED into the lamp port. Ensure the Z-adjustment screw is accessible and tighten the set screws (or collar in Nikon microscopes).
4. Observe the illumination. If needed adjust the UHP-T-LED axial focus by a Hex Key (2mm or 5/64")

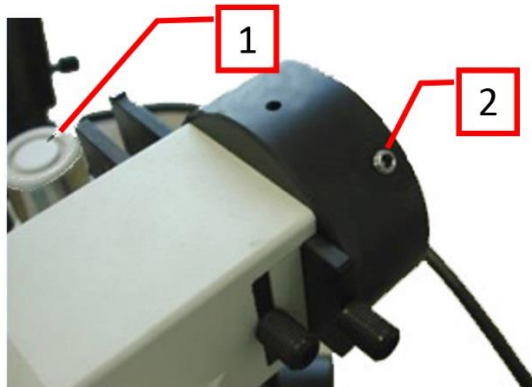

Figure 6: Olympus microscope epi-fluorescence lamp port: (1) Olympus hex screw driver, (2) Light source fixation set screws.

1.8.2 Illuminator alignment on the microscope

Z -alignment of the collimator lens is required to optimize the illumination provided by the UHP-T LED illuminator.

Adjustment of the Z placement of the collimating lens relative to the LED chip is done by slightly turning the Z-Adjust screw on the top of the UHP-T LED head (see Figure 7 below).

Note that the span of the screw motion is less than one full turn – this covers the full Z adjustment move.

Prizmatix

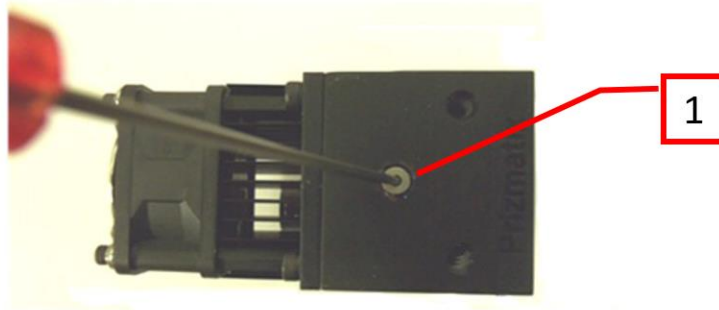

Figure 6: Z-Axis Focus Adjust: (1) Focus adjust screw

1.8.3 Disconnection of illuminator LED head from a microscope

1. Turn the power OFF and disconnect the cables from the LED head.
2. Loosen the two fixing set screws (or the F-mount collar on Nikon).
3. Pull out the UHP-T-LED head to disengage it from the microscope.

1.9 Use of UHP-T LED illuminator for table-top illumination

In case the UHP-T illuminator is used for table top application as illumination of Petri dish, the eye safety issues shall be considered. In order to minimize user and by stander exposure protection enclosure shall be considered, see example at Figure 7.

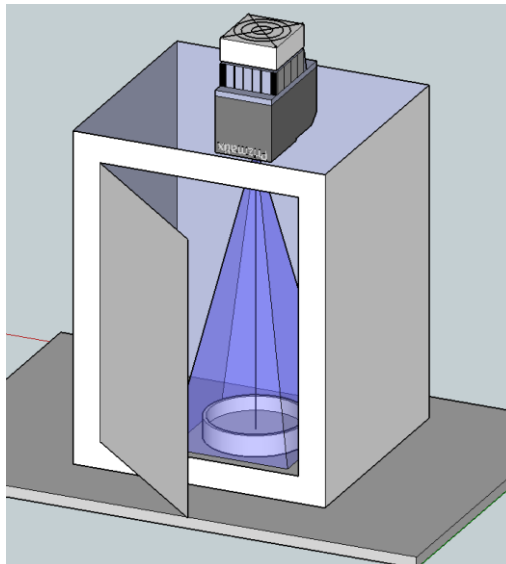

Figure 7: Protection enclosure for UHP-T LED illuminator used for Petri dish illumination experiment.

Prizmatix

1.10 LED Control by TTL and / or Analog Input

The TTL input (TTL) and Analog Input (Ain) BNC connectors are placed at rear panel of the UHPTLCC-02 controller, featuring the TTL and Ain connector and toggle switches as shown above.

To control the LED by TTL input:

- Connect the BNC cable to the TTL input and to TTL trigger source.
- Switch the "TTL Enable" toggle to **Ext** position to enable the triggering

To control the LED power via Analog Input voltage:

- Connect the BNC cable to the Ain input and to voltage source.
- Switch the "Ain Enable" toggle to **Ext** position to enable power control by analog voltage

Note: Polarity of the TTL and Ain BNC connectors: the internal pin is Positive (+). The external part of the connector is Negative (-).

Note: The Ain is intended for LED power control via Digital to Analog (D/A) modules. If Analog Input operated at frequency higher than ~100Hz the light output modulation depth will decrease.

! CAUTION!:

- The absolute maximum voltage to be applied to TTL and Ain connectors is +5.5V.
- Using more than the maximum voltage or inverse polarity may cause permanent damage to the UHPTLCC-02 Current Controller!

Cleaning

Keep the UHP-T LED illuminator head clear from dirt and do not leave it open. Make sure to close the output aperture of the illuminator with a cap when it is not in use.

The UHPTLCC current controller box can be wiped with mild wet-wipes.

! CAUTION!:

Do not attempt to use chemicals, e.g. Alcohol or Acetone – you may damage plastic components!

Prizmatix

Specifications

1.11 Electrical specifications

TTL Input		Optically isolated BNC connectors
Analog power control	%	0-100
ON/OFF		Power switch or by TTL signal
Current controller input supply voltage	V	12
Power Adaptor Input		85-264 VAC, 47-63 Hz, 1.5 A

1.12 General specifications

Operation temperature range	°C	10 - 35
Storage temperature range	°C	-10 - 55
Operating relative humidity (Non condensing)	%	<90
Head dimensions		See drawing below
Head weight	g	450
Controller dimensions (L x W x H)	mm	166 x 106 x 56
Controller weight	g	450
Power adaptor dimensions (L x W x H)	mm	175 x 72 x 35
Power adaptor weight	g	570
Power Adaptor Safety		
LED Head fan noise	dBA	38

